

What are the **advantages** of the HD polyethylene shield?

Polyx series snowploughs are known for their strong structure in high strength steel combined with an innovative HD polyethylene shield specially created by Bucher engineers which makes it easier for snow to be cleared. They are especially suitable for clearing snow on both large and small urban roads as well as extra-urban roads even with special surfaces.

One of the main characteristics of the HD polyethylene shield is its ability to clear more snow and lack of corrosion.

Tests, performed under extreme operating conditions, have demonstrated a number of important characteristics which make our product the only one of its type on the market:

- **lighter** weight which guarantees a lower angle of incidence on the vehicle's front axle
- **interchangeable** scraping edges for perfect cleaning on all types of snow
- **longer service life** guaranteed by the special materials that the snowploughs are made of

To conclude, with Polyx series snowploughs you can have the maximum without having to accept compromises!

Bucher Municipal



For local contact and support, please scan the QR code or visit buchermunicipal.com

At Bucher Municipal we design innovative solutions for cleaning and winter maintenance and help our customers to grow and make their work more efficient and profitable. With over 200 years in the business, we are committed to helping you accomplish more with less. We are proud to be considered a reliable partner and work at local level with you to create a smarter, cleaner and more efficient future.



Your Bucher Municipal contract partner:

● Bucher Municipal locations
● Distribution Partners

Driven by better



BMU Ep_POLYX_rev01 - 09/2021
The technical data and pictures are indicative and not binding.

Polyx

Front mounted snowplough with HD polyethylene shield





Neoprene scraping edge
The bi-shore neoprene scraping edge with a negative angle of attack, made in one section, adapts perfectly to the treated surface. It guarantees complete removal of fresh or thawed snow. Safe, silent and practical to use, it does not damage the road surface. Essential for joints on viaducts and on cobblestones or block paving. As well as removing all the snow, it guarantees minimum noise levels.

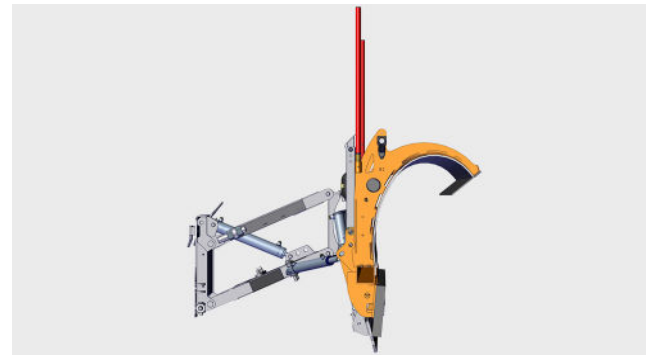

Double neoprene and steel scraping edge
In the event of icy snow, the Hardox 400 steel edge with a positive angle of attack, which can be hydraulically inserted from the driver's cab, is very high performing and safe and can easily deal with obstacles by using nitrogen accumulators which reduce the impact with the obstacle and automatically move the edge back into operating position.

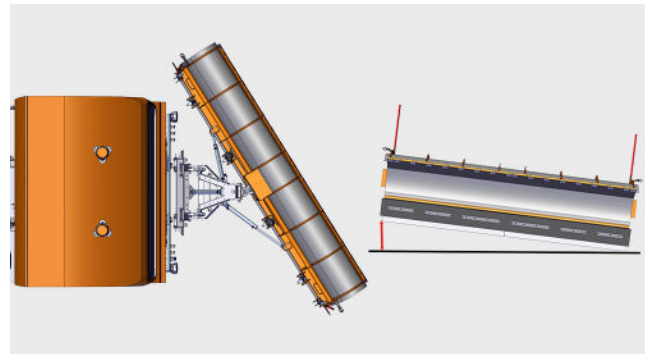

Oscillation and rotation
Two compressed polyurethane inserts allow side oscillation which adapts the edge to the road surface and keeps the side snowplough perfectly horizontal when the scraping edge is raised.

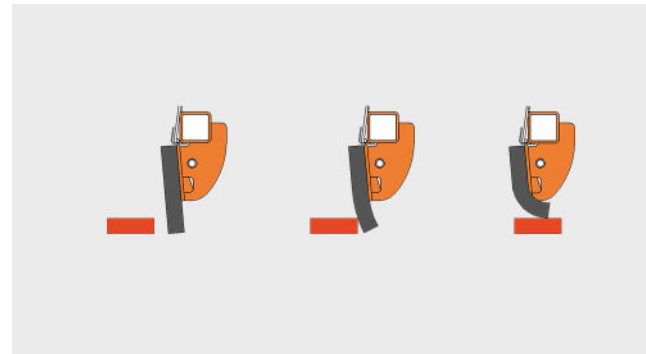

Obstacle overcoming system
In the event of impact with fixed obstacles, the elasticity of the neoprene blade allows it to deform, making it easy to overcome obstacles and allowing it to return immediately to its working position, without rebounding and without transmitting vibrations to the vehicle, all with a minimum noise level.

	S	R	L	M	
Length of scraping edge	1400+2600	2600+3400	2800+4000	3200+6200	mm
Working width	1200+2250	2300+2850	2470+3540	2850+5410	mm
Weight	215+330	315+460	505+770	795+1200	Kg
Height of side snowplough – centre/sides	650/800	805/935	955/1095	1145/1240	mm



HD polyethylene shield
The front shield consists of a strong structure in high strength steel and a recyclable HD polyethylene shield with a curved, open profile which can clear large quantities of snow even at high speed. The polyethylene puts less load on the vehicle's front axle and makes the snow less sticky with less power required from the vehicle.

Absorption of side impacts
A safety by-pass valve in the hydraulic rotation circuit allows the side impacts to be absorbed and guarantees increased operator safety.

Bi-shore neoprene scraping edge
Bi-shore neoprene scraping edge with a negative angle of attack, made in one section, ideal for all types of snow and especially fresh and thawed snow. Essential on cobblestones or block paving. As well as removing all the snow, it guarantees minimum noise levels and maximum operator comfort.

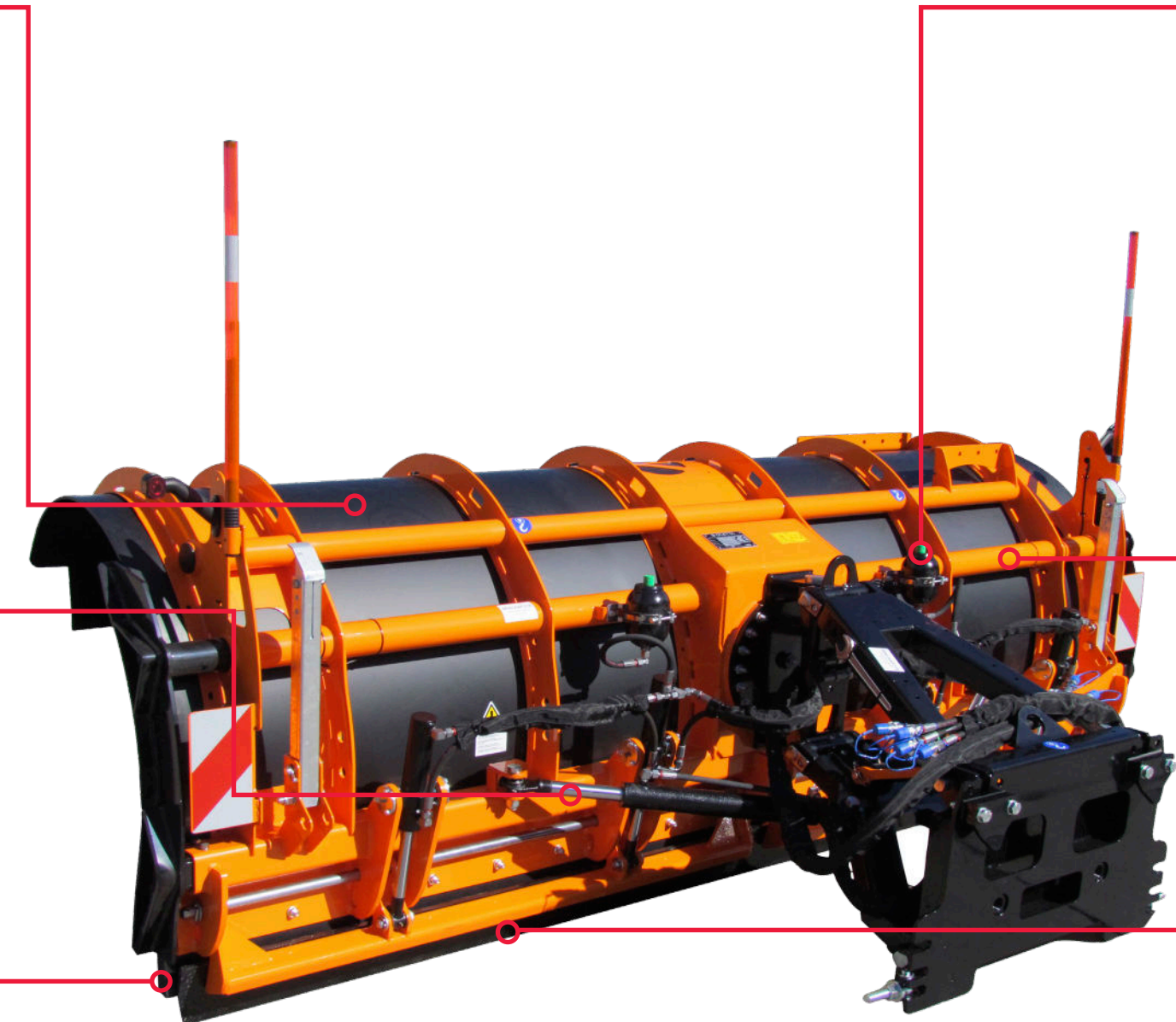

Weight reduction system (optional)
Automatic adjustment of load on ground depending on type of blade in use to prevent excessive wear of blade.

Corrosion protection
The innovative high protection painting cycle consists of a first SA2.5 shotblasting stage with different sized beads following by the application of zinc-based epoxy primer and a final coat of polyester topcoat with firing at 200° C. The painting cycle is tested for over 2000 hours in salt fog.



Double scraping edge
The snowplough configuration with a double scraping edge, the first in neoprene with a negative angle of attack, the second in wear-resistant Hardox 400 steel with a positive angle of attack, which are hydraulically interchangeable, can be used on any type of snow from very fresh to more compact or icy snow.

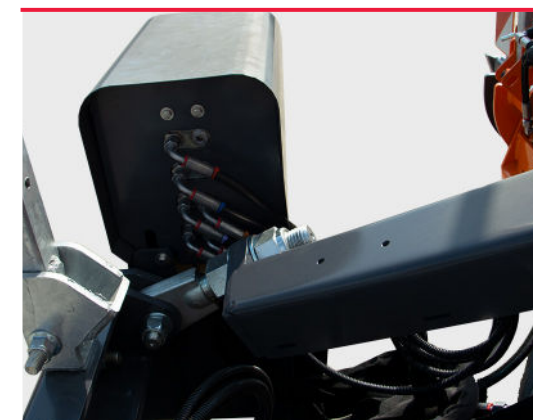

Electro-hydraulic unit (optional)
Controls movement of the snowplough when the vehicle has no hydraulic system.



EasyCom joystick control (optional)
Digital control for all the snowplough functions.

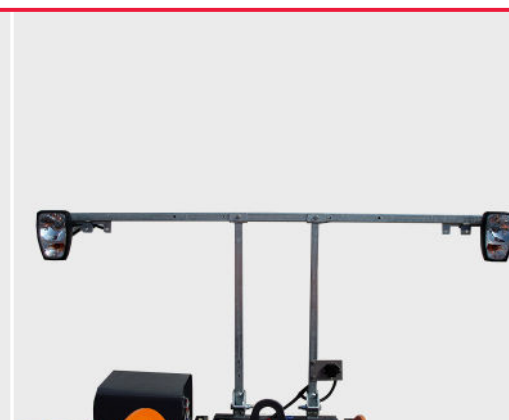

Auxiliary headlight kit (optional)
Made to comply with current traffic regulations, it duplicates the vehicle lights and indicators.

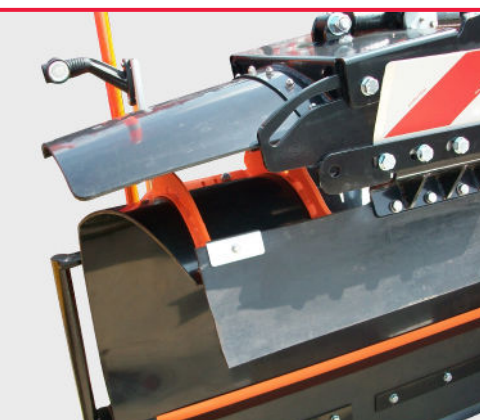

Side deflector (optional)
This allows the operator to control the snow clearance angle, preventing damage to road signs.



Lateral edges (optional)
These ensure that the shield is not damaged when the operator has to work close to side walls or Jersey barriers.

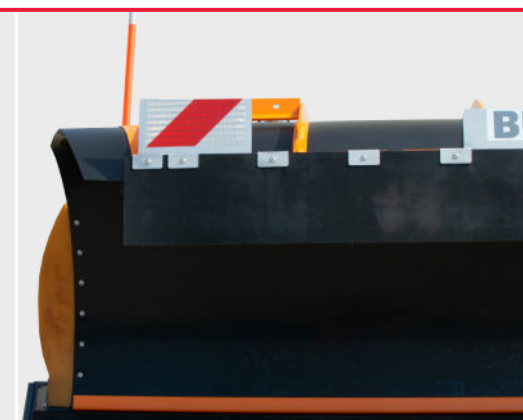

Splash guard
This prevents snow being discharged from the upper part of the shield and being deposited on the windscreen.